

Mounting Kit 53380-MKPB-QLIV

K2500HD Sierra/Silverado 4x4 2011 - 2019
K3500 Sierra/Silverado DRW 4x4 2011 - 2019
K3500 Sierra/Silverado SRW 4x4 2011 – 2019

- For the snowplow lights (2011-2014), this kit requires:
800084, 800085 or 800086 Light kit,
53617-M wiring kit and light and light Adapter 800042 (vehicle's bulb H9005 (HB3) and H11),
- Snowplow lights for models 2015 and above, this kit require:
800084, 800085 or 800086 light kit,
800087-MPX light adapter for Front Installation.

See page #13 for UI technical bulletin #124k for Intermittent Cluster, Radio and HVAC Display resets on Snow plow trucks.

▲ Warning

Arctic Equipment Manufacturing Corporation (Arctic) does not assume liability for damage to your motor vehicle resulting from the attachment or use of an Arctic snowplow. The purchaser assumes all vehicle risk associated with the attachment and operation of this snowplow.

The Arctic snowplow you purchase must be used only on vehicles equipped with the manufacturer's snow plow preparation packages. Snow plowing without the original plow preparation package may damage your vehicle. The added weight may impair the operation and control of your vehicle. Snow plowing with a vehicle not recommended for that purpose by the manufacturer may void your new vehicle warranty. If your vehicle is not equipped with an original snow plow preparation package, additional equipment may be necessary before snow plowing. Please consult your vehicle and snowplow dealers prior to the purchase and installation of the snowplow. The installation of such parts however is not a full substitute for the original equipment snowplow preparation package.

The loaded vehicle, including all aftermarket accessories, the snowplow, passengers and cargo, must not exceed the gross vehicle weight ratings (GAWR), front gross axle weight rating (FGAWR) or rear gross axle weight rating (RGAWR) specified on the Safety Compliance Certification Label located in the driver's side door opening. It is the operator's responsibility to verify that these rating are not exceeded. The use of rear ballast weight may be required to prevent exceeding the front GAWR.

To determine the Gross Axle Weights for your vehicle, including all aftermarket accessories, the snowplow, passengers and cargo, take your loaded vehicle and the snowplow to a scale. With the snowplow attached, place the front wheels of the vehicle on the scale to get the front gross axle weight (FGAW). To get the rear gross axle weight (RGAW), place the back wheels of the vehicle on the scale.

Installation Instructions

Before drilling any holes in the firewall or frame, move brake lines, fuel lines and/or electrical wiring from the path of the drill. Brake and fuel lines must also be clear of any fasteners.

Do not under any circumstances disable, remove or relocate any sensors or other components related to the operation of the air bags.

General order of installation:

- install all components (mounting bracket, thrust arm and spreader bar) and all fasteners finger tight (snug) through existing holes,
- use removable grade LOCTITE #242 on all bolts,
- drill necessary holes and
- tighten all hardware.

After first use, retighten all mounting bolts, thereafter check mounting bolt tightness periodically and at the start of the season.

Before proceeding, read instructions carefully and familiarize yourself with the components and hardware.

NOTE: It may be necessary, on some vehicles, to use a form of load booster to decrease the vehicle's front suspension sag when snowplows is attached to the vehicle. This can be done with the use of, booster springs, supplementary air bags or similar load boosting devices. It is up to the customer to choose and purchase the product that suits this application.

Arctic Equipment Manufacturing reserves the right, under its product improvement policy, to change construction, design details or specifications without notice or without incurring any obligation

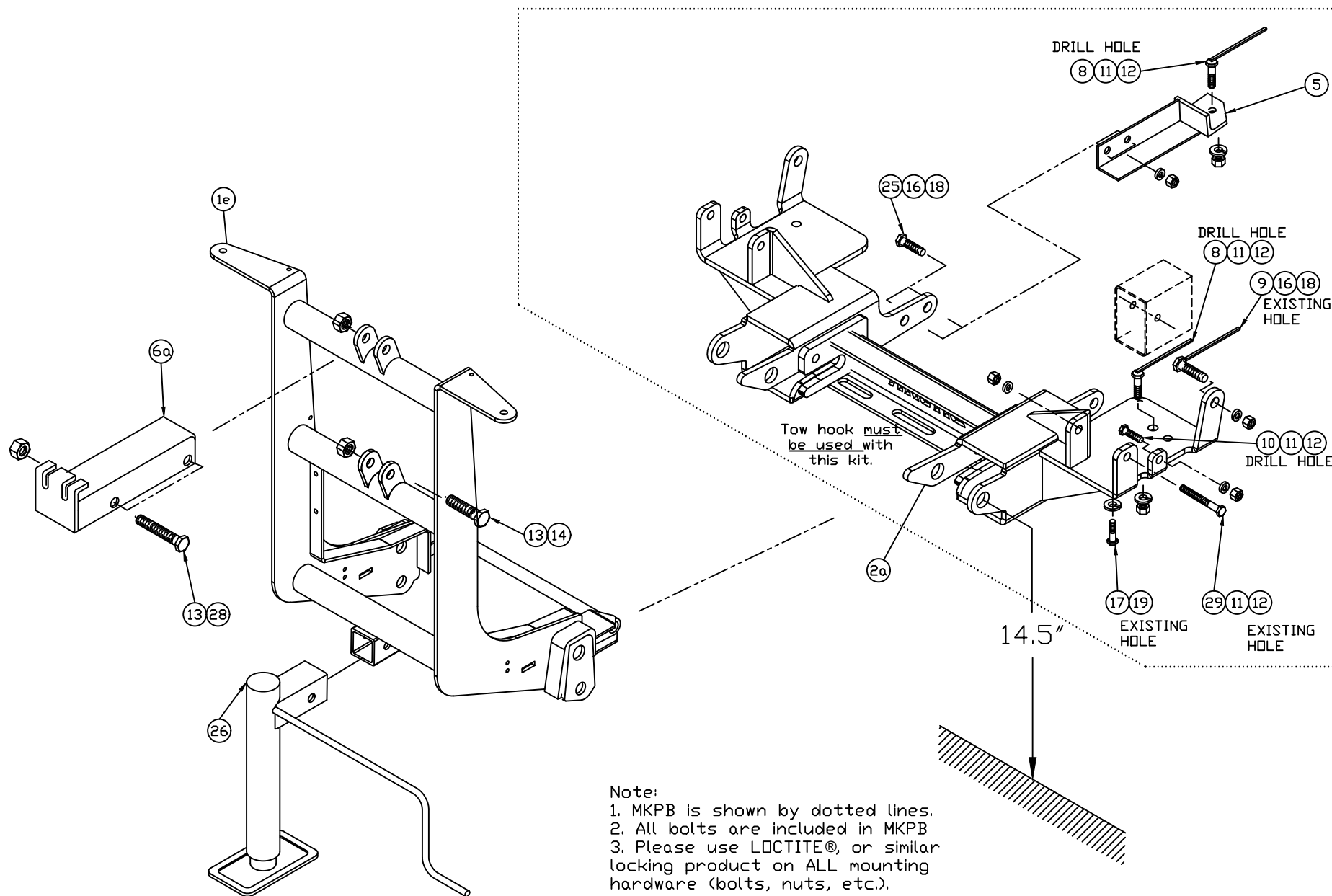

Mounting Kit 53380-MKPB			
Item	Part #	Description	Quantity
1a*	53170-D-GA	Lift Frame, QUIK*LINK® II, low mount	1
1c*	53564-D	Lift Frame, QUIK*LINK® IV, low mount	1
1d*	53171-D-GA	Lift Frame, QUIK*LINK® II-Hi boy	1
1e	53517-D	Lift Frame, QUIK*LINK® IV-Hi boy	1
2*	53381-D	Mounting Bracket	1
2a	53557-D	Mounting Bracket QLIV	1
3*	52208-B-GA	Light Brace Galvanized	2
4*	53385-01-B	Thrust Arm DS	1
5	53385-02-B	Thrust Arm CS	1
6*	50069-C-GA	Lift Channel (1 ½" cylinder)	1
6a	52612-B-GA	Lift Channel (2" cylinder)	1
7	52209-B-GA	Light Antler Galvanized	1
8	52575-06-A	½" Bolt Weldment	4
9	52575-05-A	5/8" Bolt Weldment	2
10	HH-00972-090	½"x1 ½" Bolt	4
11	HH-00457-001	½" Lock washer	8
12	HH-00460-002	½" Hex Nut	8
13	HH-00973-007	3/4" Thin Collar Locknut	3
14	HH-00972-153	3/4"x3 ½" Bolt	2
15*	HH-00972-149	3/4"x2 ½" Bolt	1
16	HH-00457-003	5/8" Lock washer	6
17	HH-00909-032	12mm x 45mm Bolt Gr10.9	2
18	HH-00460-001	5/8" Hex Nut	6
19	HH-00933-004	12mm Lock washer	2
20*	52348-M	Mounting Pin, Ass'y	2
21*	HH-00293-006	1/4"x1" Bolt	4
22*	HH-00457-006	1/4" Lock washer	4
23*	HH-00341-002	1/4" Flat washer	4
24*	HH-00294-001	1/4" Hex Nut	4
25	HH-00972-129	5/8"x1 3/4" Bolt	4
26	52373-M	Jack Assembly	1
27*	50999-B	Blade guides	2
28	HH-00972-155	3/4" x 4" UNF Cap screw	1
29	HH-01081-102	½"x 5" Bolt grade 8	2

QUIK*LINK is a trademark of Arctic Equipment Manufacturing Corporation

Note: * These items are not shown on the drawing.

INSTALLATION INSTRUCTIONS

For 2015 Chevy – The bumper modification and the lights removal:

a) In order to remove the headlamp, remove the engine compartment cover, the grill and the bumper.(see picture below, access to headlamp screw)



b) Remove plastic portion from the bumper.



For 2015 GMC – The bumper modification and the lights removal:

a) Remove the engine compartment cover by removing fasteners.



- b) Remove the grille fasteners and pull out the grille. Remove the bumper fasteners and pull out the bumper.
- c) To remove the headlamp, the plastic trim strip must be removed first. Remove the fasteners hidden behind the plastic trim piece and the wheel well fender.



- d) Remove the fastener to the side of the plastic trim and remove the trim.
- e) Remove the two fasteners on the underside of the headlamp trim. The headlamp is held by four fasteners. Two of them are on the top, one on the side and on in the front.
- f) Remove the fasteners as shown below (attaching fender trim to the wheel well). One fastener is located above two fasteners shown on the picture.



g) Remove air dam and all plastic support from the bumper. Cut steel support on the bumper shown below.

Cut the corner as shown below on the both sides (driver and curb).



After cutting.



The Bumper chrome section to be cut as shown below.

Before cutting



After cutting



For 2013-2014 trucks:

1. Do not remove bumper from truck.
2. Do not tighten any hardware until instructed to do so.
3. Cut out 41" of the bottom of bumper (air dam) in order to fit lift frame and mounting bracket. (see attached picture)
4. Remove tow hooks and tow hook bolts. Remove splash pan from the bottom of the truck in order to install thrust arms.
5. Install mounting bracket (2a). Be sure that mounting bracket (2a) is tight against vehicle frame. Install ½" x 5" bolts. Drill ½" holes through side of the frame and through the bottom of vehicle frame (back hole), using ½" holes in mounting bracket (2a) as guides. Install ½" x 1.5" bolt (10) through the side of vehicle frame and secure it with 1/2" lock washer (11) and nut (12).
6. Install tow hooks to their place. Secure mounting bracket (2a) using ½" x 5" bolt (29) (goes through tow hook sleeve), ½" lock washer (11) and ½" hex nut (12). Install 12 mm bolt (17) and lock washer (19) through the bottom of the truck frame into tow hook.
7. Install 5/8" bolt with welded handle (9) through existing hole in the vehicle frame, and secure it with lock washer (16) and nut (18). Also install 1/2" bolt with welded handle (8) through the bottom of the frame, and secure with lock washer (11), and hex nut (12).
8. Attach thrust arm (4)(5) to mounting brackets (2a) using 5/8" bolts (25), 5/8" lock washer (16), and 5/8" hex nuts (18). Drill ½" hole through the bottom of vehicle frame, using ½" hole in the thrust arms as guide. Install thrust arm driver side (4) and thrust arm curb side (5) to bottom of vehicle cross member using 1/2" bolt with welded handle (8), lock washer (11), and hex nut (12).
9. Tighten all hardware.
10. Install lift frame (1e). Slide inside of the mounting bracket (2a).
11. Install lift channel (6a) and front mounting pump (from hydraulic kit) to lift frame (1e) using 3/4" x 3 ½" bolts (14), and 3/4" locknuts (13). Use 3/4" x 4" bolt (28) and 3/4" locknut (13) to attach lift channel (6) to front mount pump (or lift cylinder). *Do not over tighten as this assembly must be able to pivot.*
12. Use 1/4"x1" bolt (21), 1/4" flat washer (23), 1/4" lock washer (22) and 1/4" hex nut (24) to fasten blade guides to blade

13. Return any unused items to the customer so that the vehicle can be returned to its original condition if the snowplow is removed.
14. See separate installation instructions for the hydraulic pump and headlight kit.



Suggested torque value for bolts				
Thread Size	Grade 5		Grade 8	
	Dry (ft. lb)	Oiled (ft.lb)	Dry (ft. lb)	Oiled (ft.lb)
¼-20	8	6	12	9
¼-28	10	7	14	11
5/16-18	17	13	24	18
5/16-24	19	15	27	21
3/8-16	31	24	44	34
3/8-24	35	27	49	38
7/16-14	49	38	70	54
7/16-20	55	42	78	60
½-13	75	58	105	82
½-20	85	65	120	90
5/8-11	150	115	210	165
5/8-18	170	130	240	185
¾-10	270	205	375	290
¾-16	295	230	420	320
7/8-9	395	305	605	455
7/8-14	435	335	670	515
1-8	590	455	905	695
1-14	660	510	1030	785

If the truck light (2011- 2014) has a plug as show on the picture below, use our adapter 800042. Disconnect connectors (2x) from the light and connect to our 800042 Light adapter.

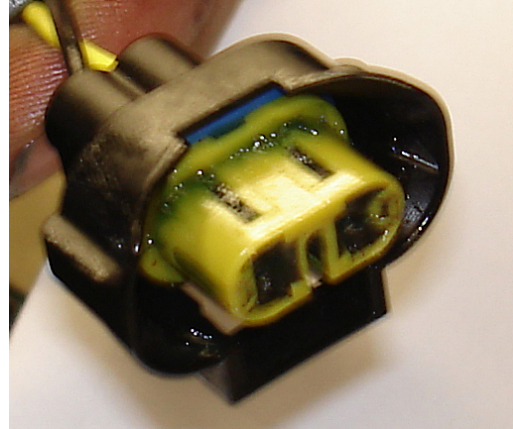

Cut the rubber booth from the 800042 Light Adapter (see picture below) and plug into OEM plug. Use a zip tie to secure the plugs.



Arctic Equipment Manufacturing Corporation reserves the right under its product improvement policy to change construction or design details and furnish equipment when so altered without reference to illustrations or specifications used herein.

TECHNICAL BULLETIN

Thursday 12, July 2018

Please find the technical bulletin on the next page for Intermittent Cluster, Radio and HVAC Display resets on trucks when snowplow installed on several GM trucks.

Also find the information about how to attach blunt cut wires coming from GMC Snowplow Jumper harness to the solenoid on Page #6, 7 and 8 or [click here to navigate to these pages](#).

Basically, Red/Orange wire from the Jumper harness is attached on the solenoid (Battery Cable Plow Side) and Black wire from the Jumper harness goes to the ground (chassis). Mentioning that, dealer or a customer has to run two wires 16ga from these blunt cut wires to the solenoid and to the ground.

If you have any questions, please contact us at: (866) 757-1243 or web@arcticsnowplows.com

Subject: Intermittent Cluster, Radio and HVAC Display Resets on Snow Plow Trucks

Models/Years Affected: 2014 - 2018 Chevrolet Silverado 1500 LD
2015 - 2019 Chevrolet Silverado 2500-3500 HD
2014 - 2018 GMC Sierra 1500 LD
2015 – 2019 GMC Sierra 2500-3500 HD
With Snow Plow Prep Package (RPO VYU)

Origination Date: November 30, 2015

Revision Date: November 7, 2019

ADVISORY:

Notice: GM Dealers refer to the latest version of Service Information PIT#5387 for labor code/time information

REVISED TO UPDATE MODEL YEAR COVERAGE

Condition/Concern:

Trucks equipped with option VYU [Snow Plow Prep] and a snow plow, may exhibit occurrences in which the Instrument Panel Cluster (IPC), Radio and HVAC displays may “blank out” or reset after changing the snow plow position. This condition is caused by a system voltage over-shoot phenomenon called ‘load dump’. When the large electrical draw of the plow pump motor is suddenly removed the field energy that is built up in the alternator causes a system voltage overshoot that momentarily moves above the normal design operating levels for the module displays. As a result the displays will shut down or reset causing the momentary blank out condition. The modules are designed to do this and immediately recover. *No modules* should be replaced for this condition.

Repair/Recommendation:

Contact your local GM Dealer for an appointment to install **PN 84288774 VYU Snow Plow Jumper harness** per the latest version of **GM Service Bulletin PIT#5387**. If your truck has RPO VYU and did not come with the harness parts they may be ordered by your dealer.

Note: This jumper harness and installation will be provided [one time] without charge. Installation charges will be waived only if the jumper is installed at your GM dealer.

General Motors Upfitter Integration
<http://www.gmupfitter.com>

Installation Instructions**1) Single alternator systems:**

- a) Unplug the 2-way connector on the alternator.
- b) Identify the master alternator connector [at the very tip of the harness when it is fully extended]. Insert it in the alternator.
- c) Take the original alternator connector and plug it into the mating jumper harness connector.
Note: In this case the second alternator connector will be unused and will remain capped and tied to the harness bundle.

2) Dual alternator systems:

- a) Unplug the control connectors on both alternators.
- b) Identify the master alternator connector [at the very tip of the harness when it is fully extended]. Insert it in the 'master' alternator on the RH side of the engine.
- c) Identify the 'slave' alternator connector on the jumper harness and insert it in the LH 'slave' alternator. Insert the removed LH alternator connector into the [unwired] cap on the jumper harness.

3) All systems:**a) Service part [early] version:**

- i) Route the snow plow jumper harness along the existing harness routing where possible and secure the relay center with tie straps as shown in Details 3.1.1-3. Allow slack for engine roll and upright orientation of the relay center to prevent water intrusion/collection.

b) Factory shipped version [parts bag included with new vehicle]:

- i) Remove the harness and loose parts from the shipping bag/container. Locate the new corner brace pn 84234282 [it should be painted black but our pictures are of an unpainted part] and the nuts and bolts that will be used to attach the relay center portion of the harness.
- ii) For a complete *picture book sequence* for the installation see Details 3.2.1-7.
- iii) Route the snow plow jumper harness along the existing harness routing where possible and allow slack sufficient to secure the relay center to the [new flat] corner brace with the nuts and bolts included in the parts bag.
- iv) Remove the Radiator Air Upper Baffle and Deflector by unclipping it from the radiator.
- v) Remove and discard the LH front pencil brace as shown and install the new flat corner brace.
- vi) Attach the relay center to the corner brace and the brace top the truck as shown.

4) All systems final [signal] connection:

- a) An operating signal must be identified to operate the small relay in the jumper harness. This signal should go ON and OFF with the plow pump motor. The relay requires low power < 1 amp so most any signal will do without loading issues. The schematic shows the control terminals on the motor solenoid which is the most common connection point.
- b) Using a test lamp try various connection points on the plow control wiring to identify a signal that will illuminate the test lamp only when the motor is running.

Note:

Some plows will present hot [B+] to both motor solenoid control terminals until one side goes to ground. As long as the lamp works right the jumper can be connected the same way. Connect the blunt cut red and black wires across the same signal source as was used to operate the test lamp. Normally the red wire will go to B+ and black to ground. [If both connection points are at B+ when the motor is at rest then put the black wire to the side that goes to ground when the motor runs and the red one to the constant B+ connection.]

- c) If the operating signal must be obtained outside of the engine compartment [on the plow itself] then **two sets** of inline connector will be required. **[Order GM service kit, 2 each M 2W 19119346 and 2 each F 2W 19119765 connectors]** Using 2 sets of connectors will allow tethered caps to be fashioned for when the plow is disconnected. Secure the wires and caps appropriately to assure durability. See figure 4.

Additional Reference Information

Fig 1: Jumper harness wiring schematic

VYU Service Harness for both single and dual generator trucks

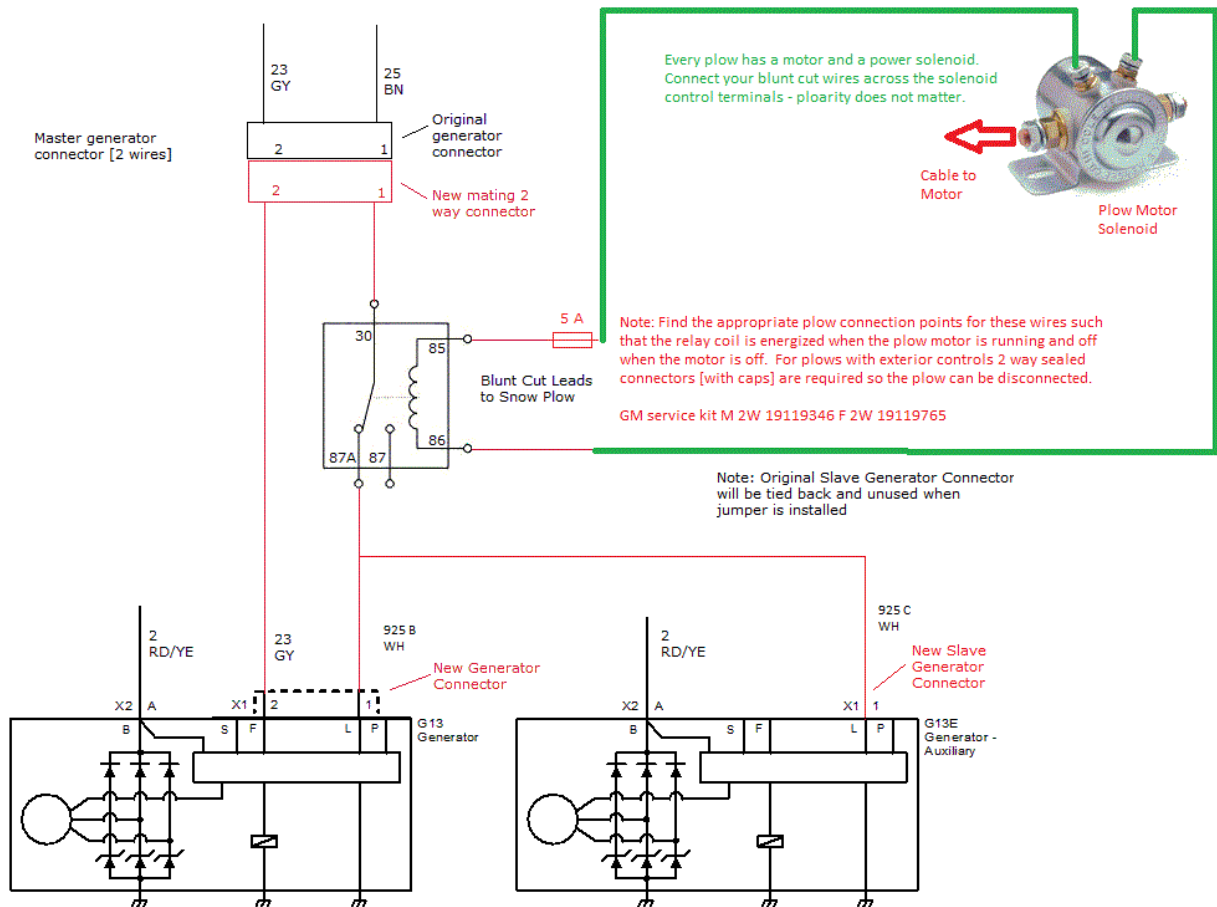

Note: To identify the signal needed by the jumper harness perform the following test. Any connection point that passes this test can be used. The best case is a signal from the wiring that remains with the truck but if that is not found then the signal must be found out on the plow itself.

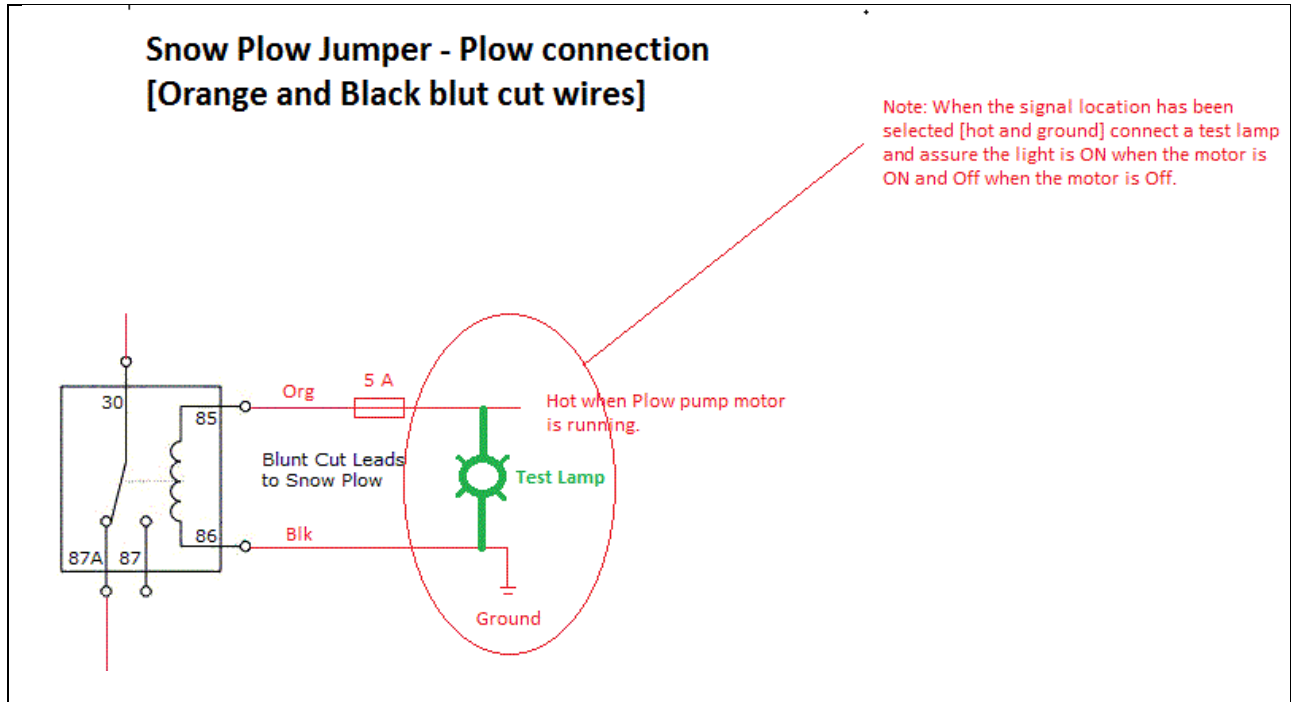

Fig: 2 Jumper Harness - Component Details

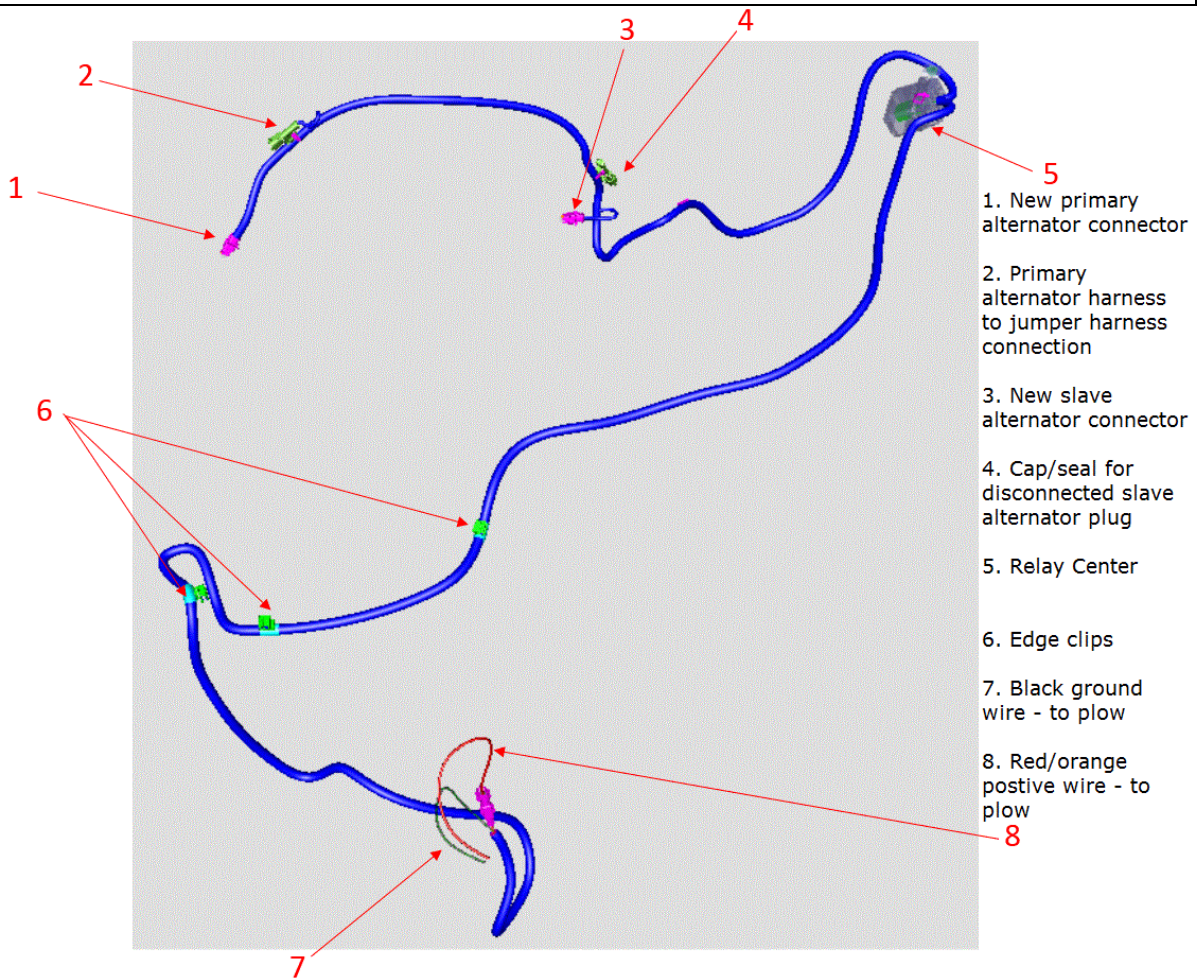

Fig: 3a Jumper Harness Layout – single alternator [see detail 3 for updated relay mounting]

VYU Single Alternator - Jumper Harness

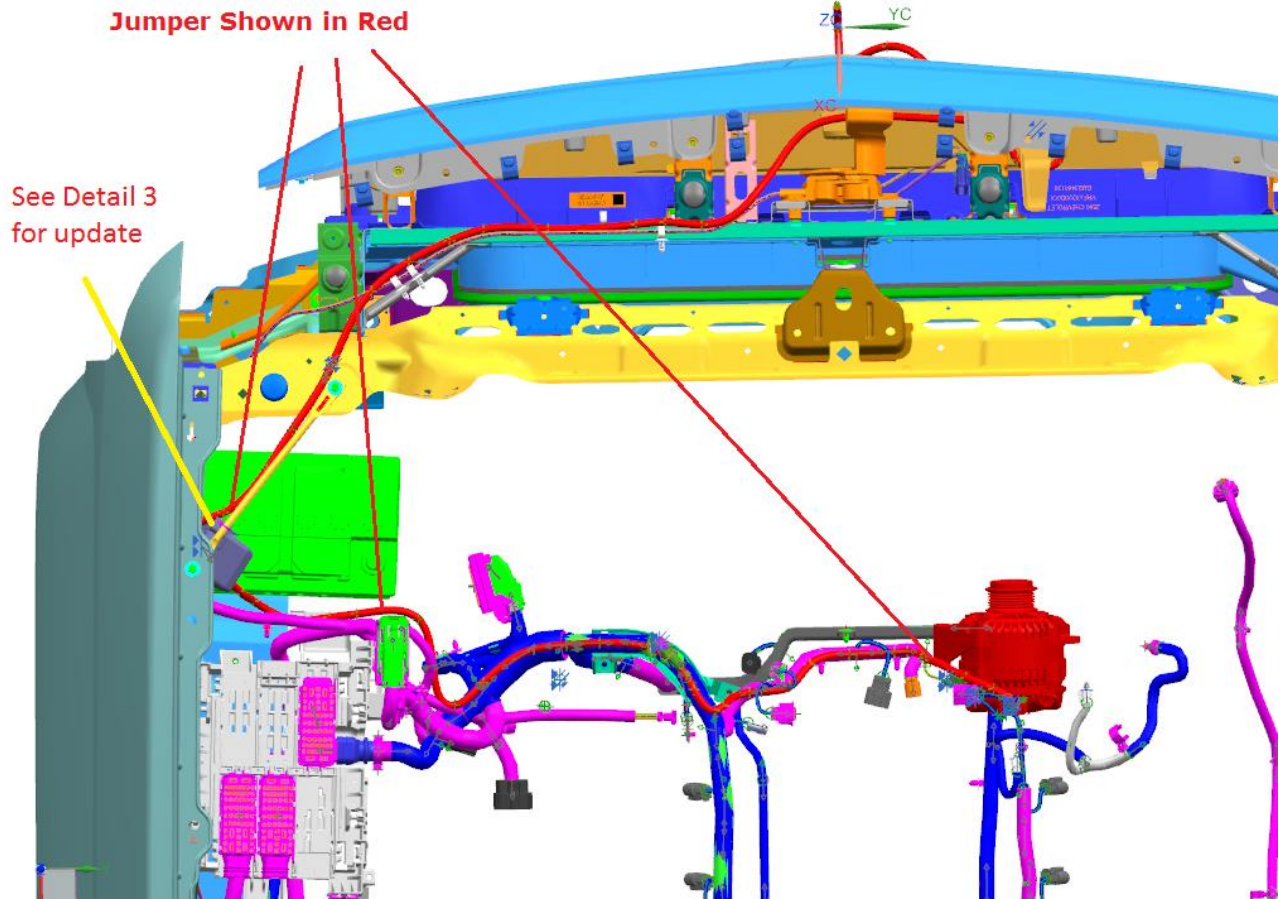
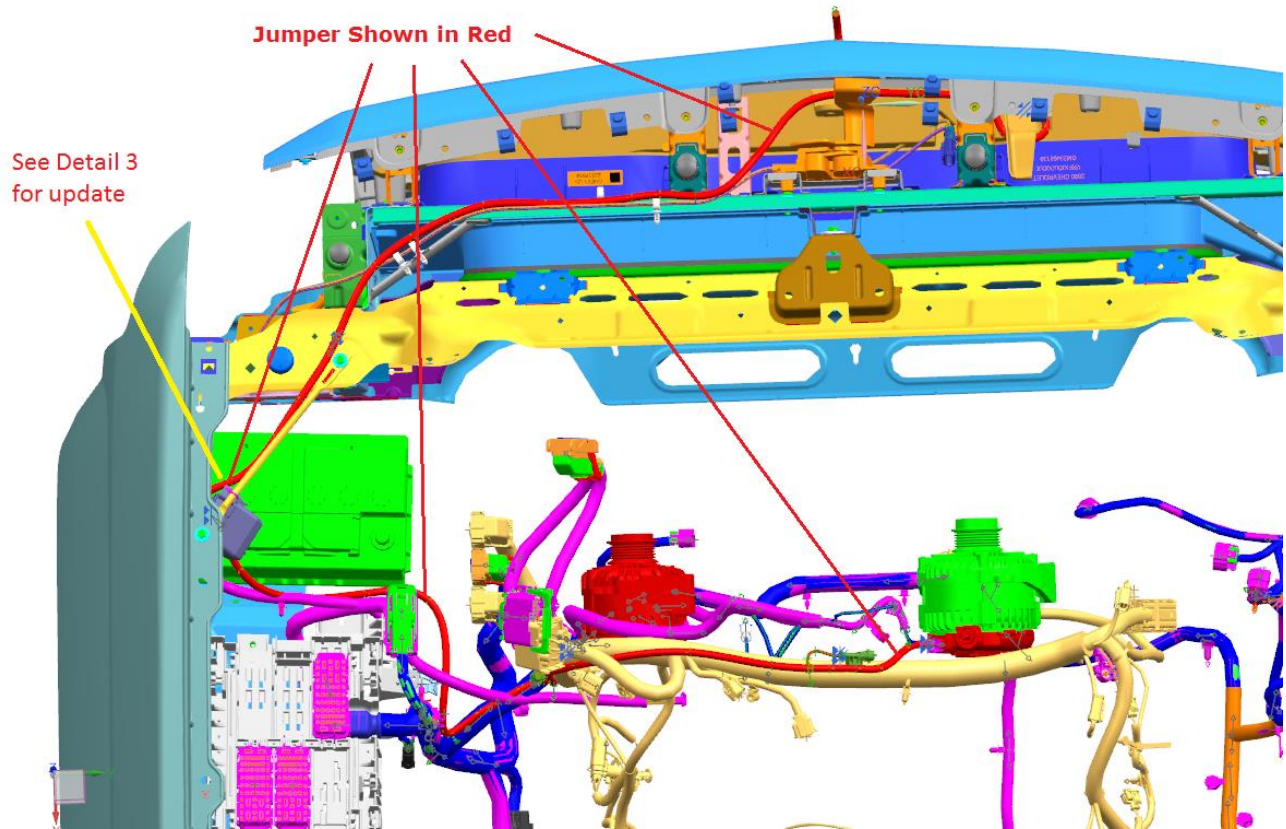

Fig: 3b Jumper Harness Layout – dual alternator [see detail 3 for updated relay mounting]

VYU Dual Alternator - Jumper Harness



Layout Details

- 1. Primary Alternator
- 2. Slave Alternator
- 3. Relay Center and [new] corner brace
- 4. Wires to plow [fused + & ground]

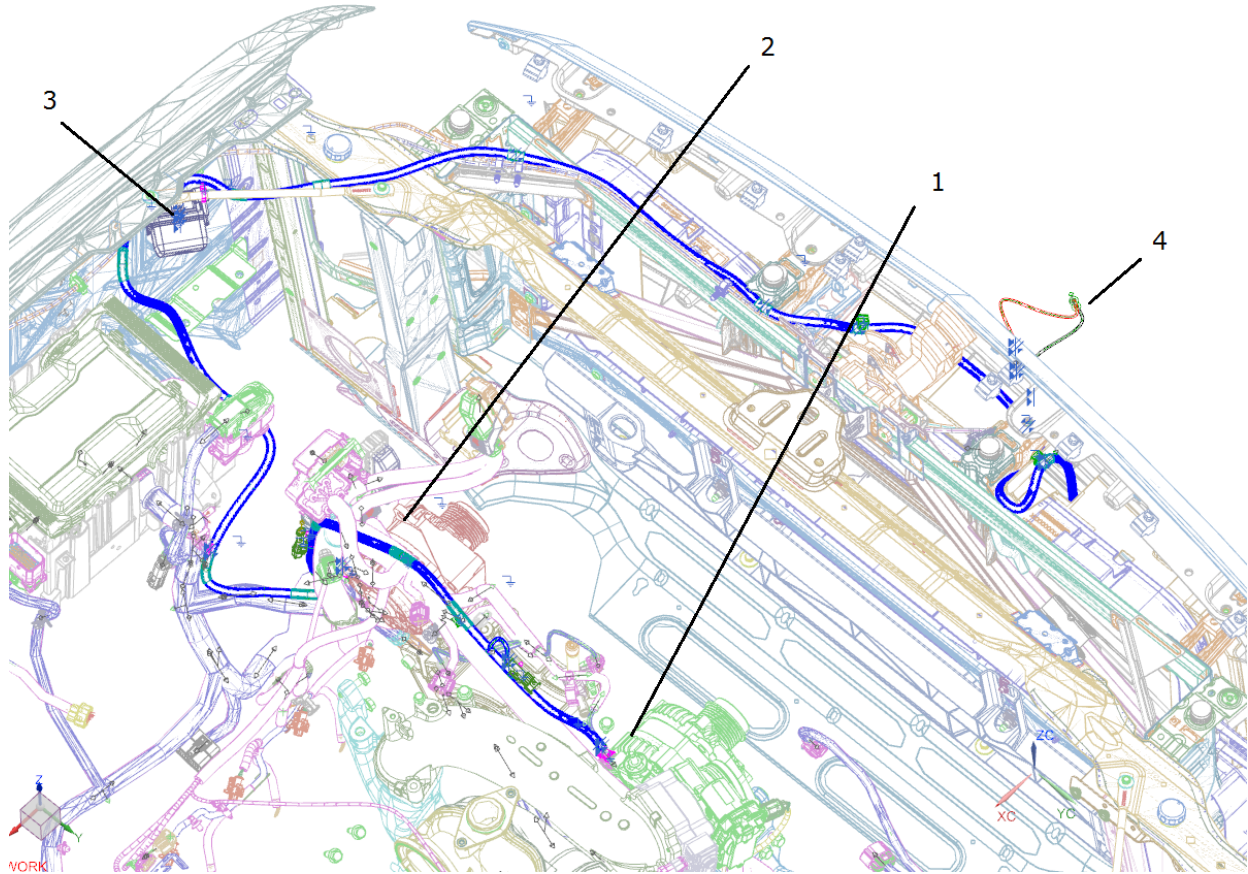

Detail 1

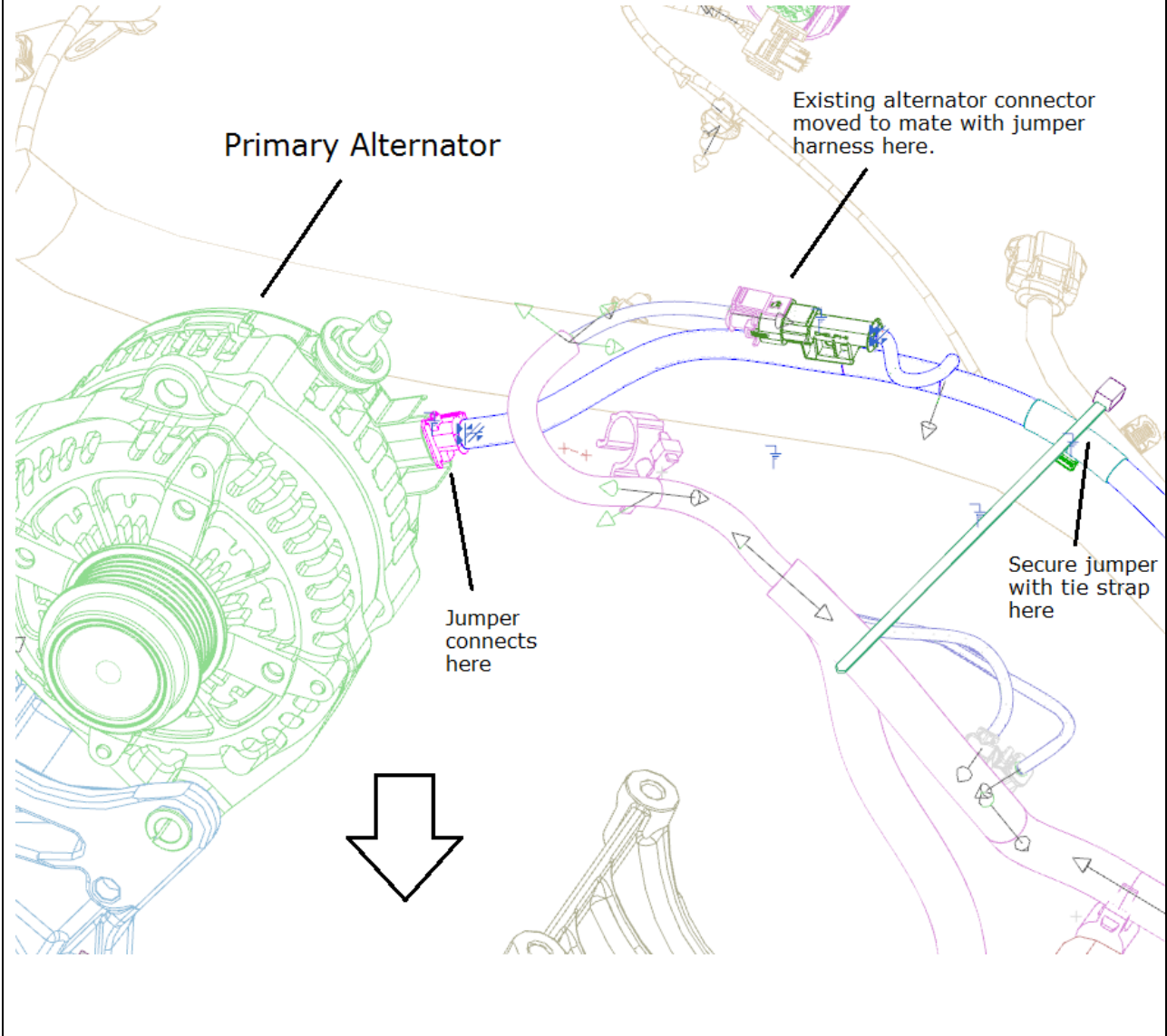

Detail 2

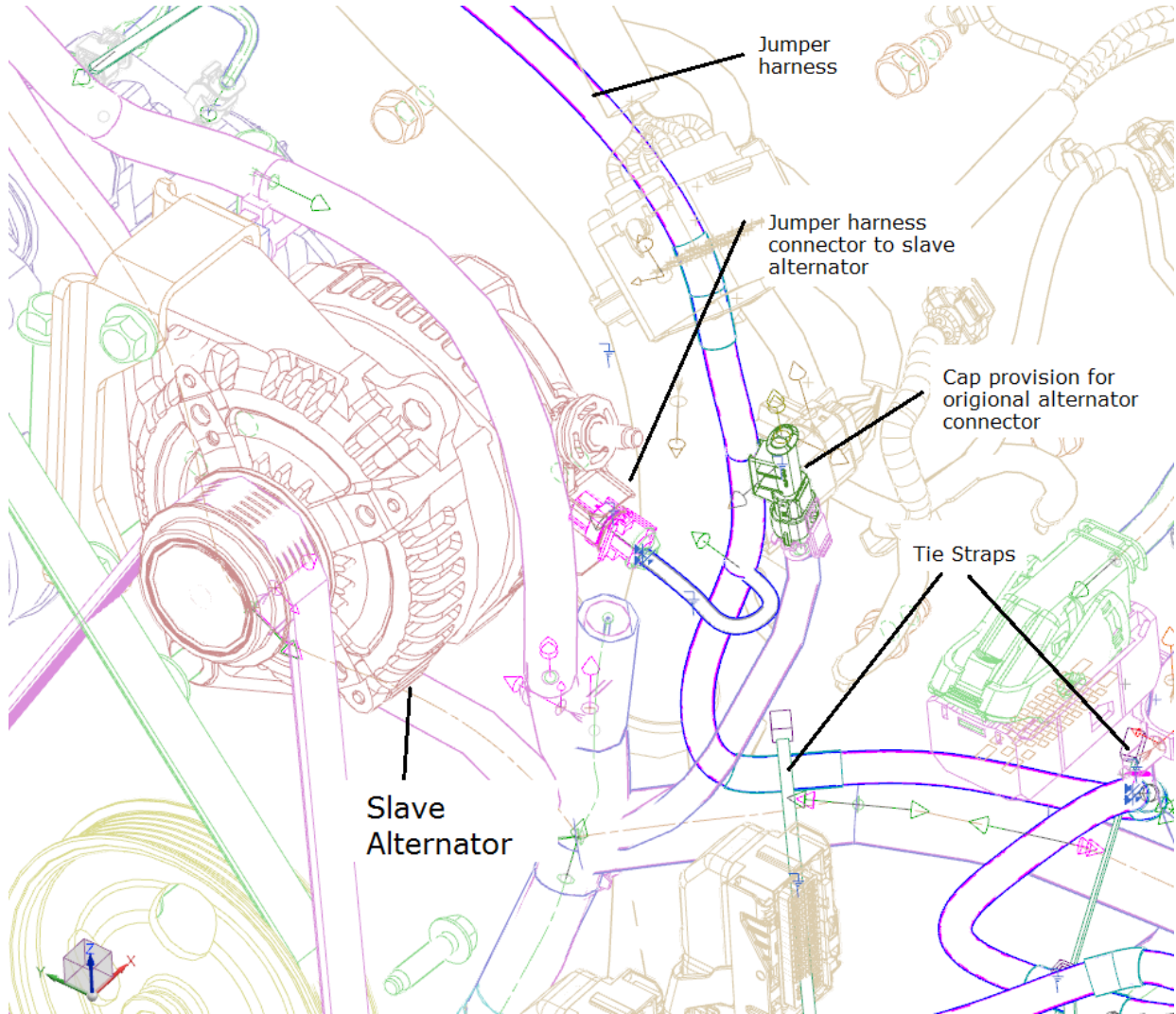

Detail 3.1.1

Details 3.1.1-3 apply to service part and not the factory included [loose shipped] part.

See Details 3.2.1-7 for the later version factory harness that comes with a new truck.

Add tie straps to relay

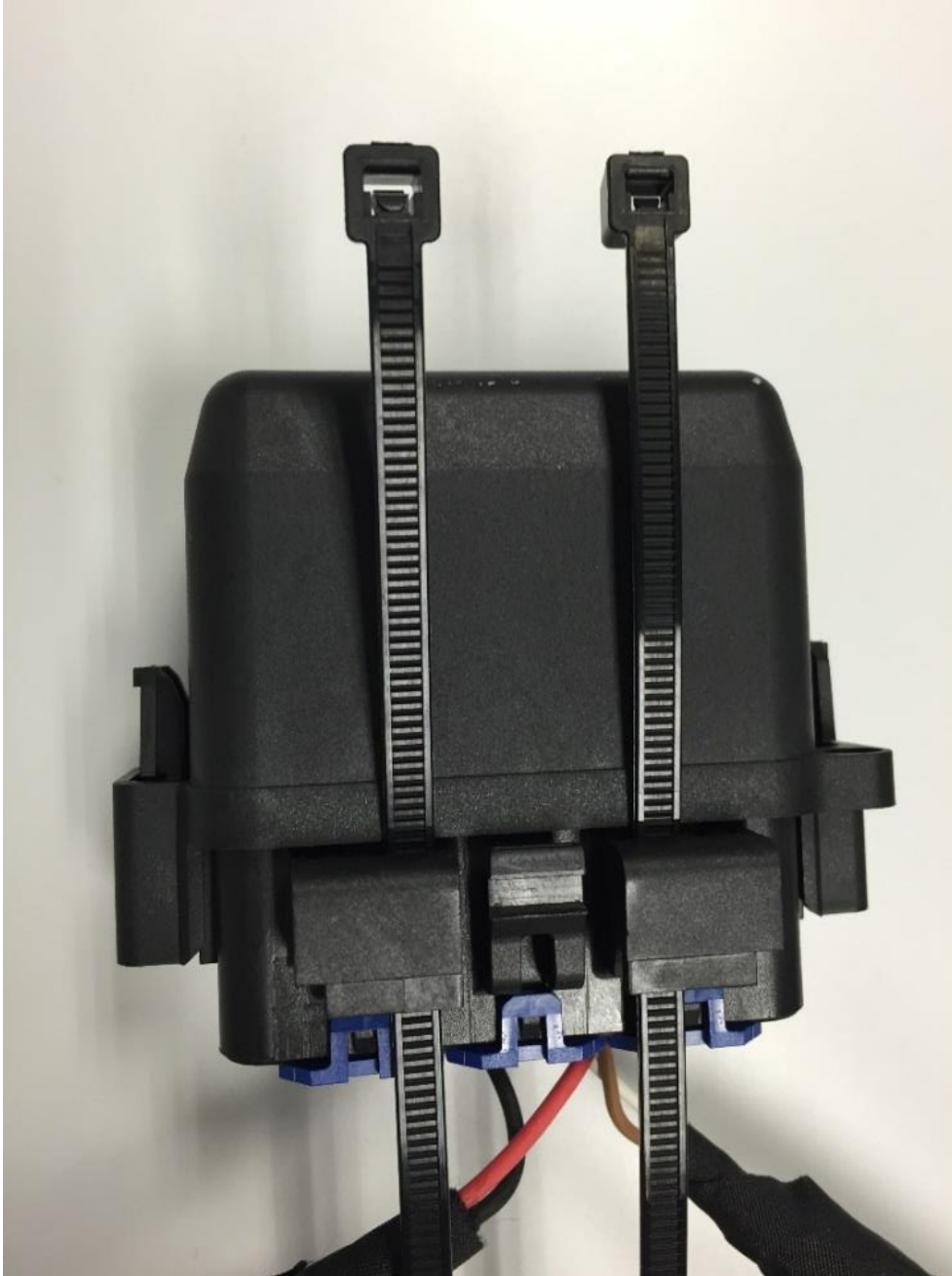

Detail 3.1.2

Single Battery Trucks

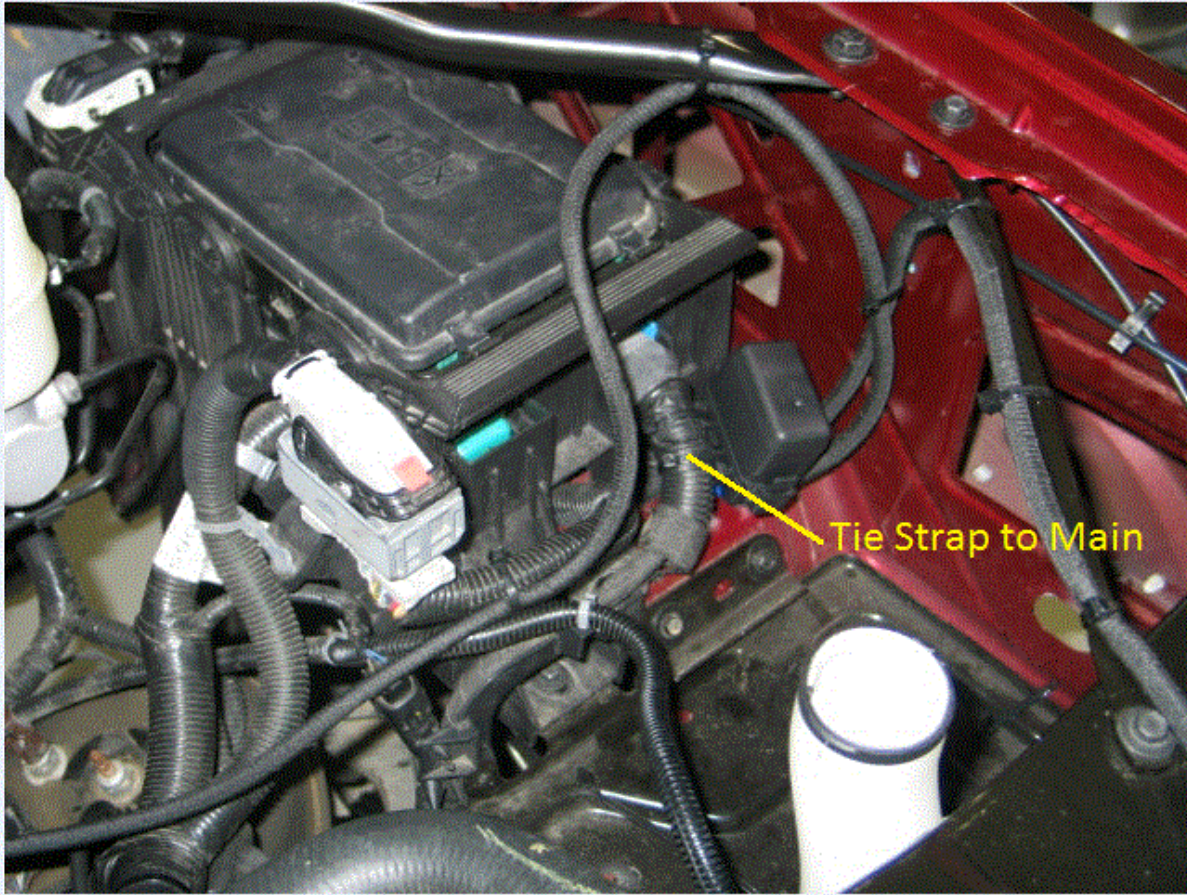

Detail 3.1.3

Dual Battery Trucks

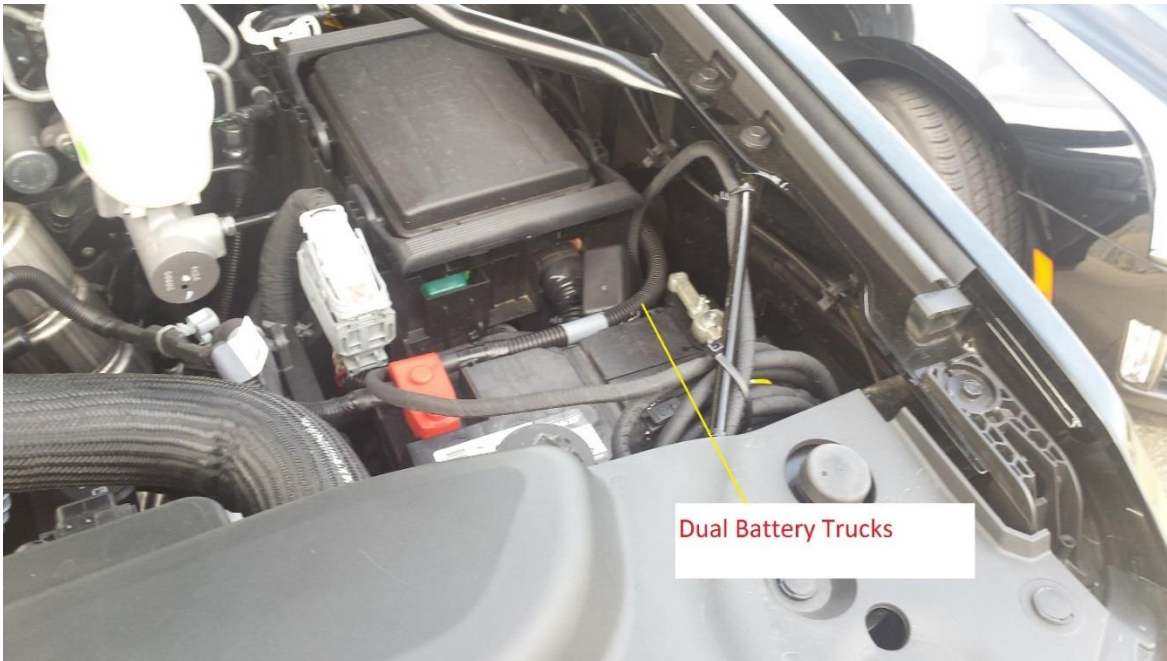

Detail 3.2.1

The following details 3.2.1 – 7 apply only to trucks that came with harness components [loose shipped] from the assembly plant.

Remove the Radiator Air Upper Baffle and Deflector.



Detail 3.2.2

Identify the new flat painted corner brace pn 84234282. [unpainted version shown]



Detail 3.2.3

Relay center and bracket details.



Detail 3.2.4

Remove the [round] left front corner brace shown here.



Detail 3.2.5

Assemble the relay bracket to the flat corner brace using hardware provided. Snap the relay bracket into the feature on the relay center.

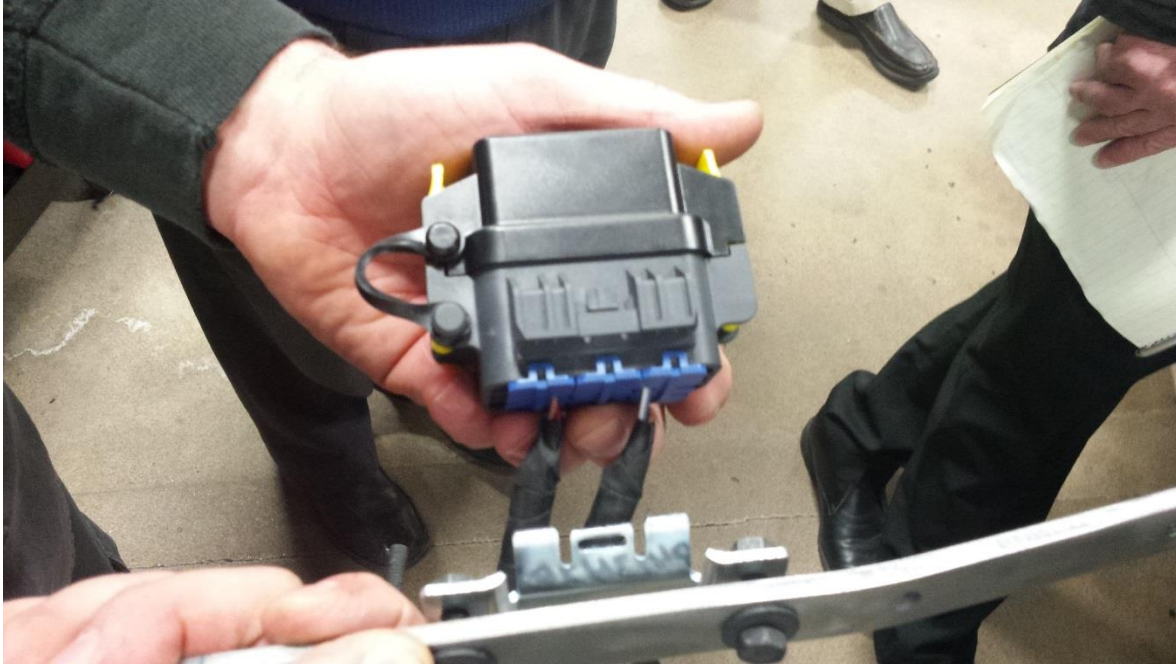

Detail 3.2.6

Position the corner brace and relay center assembly.



Detail 3.2.7

Mount the flat corner brace assembly as shown.

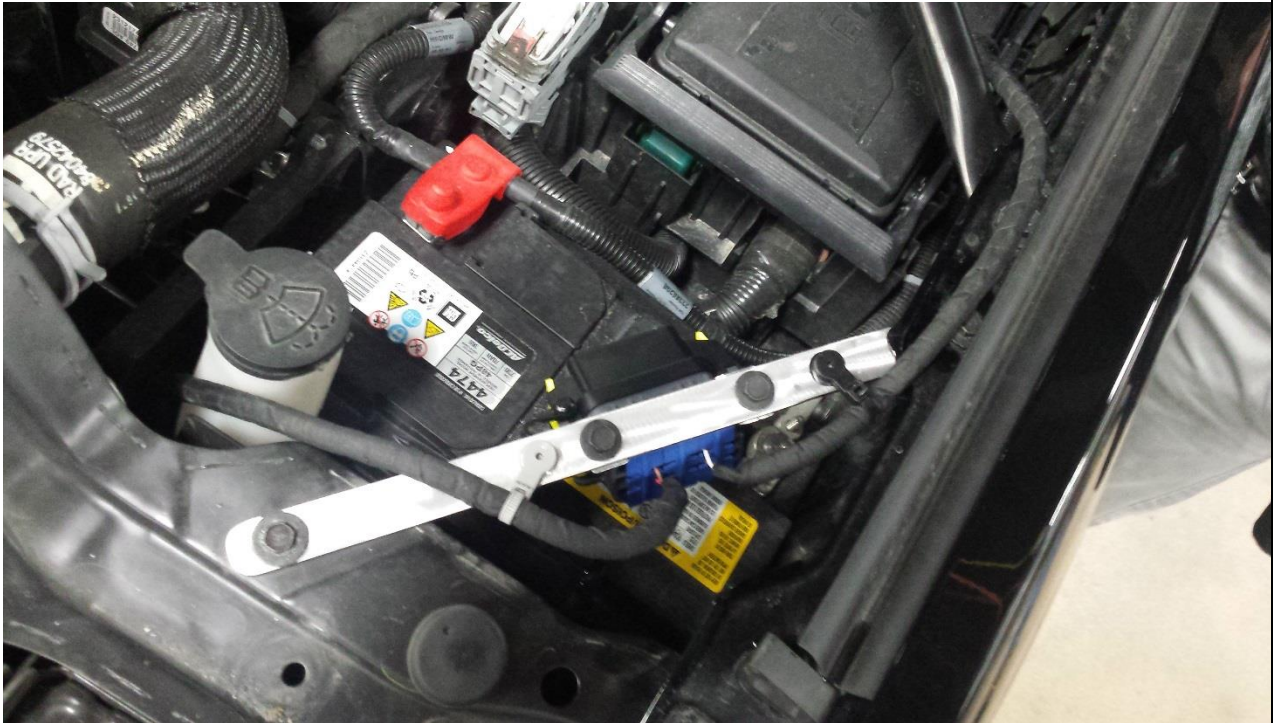

Detail 4

On units where the control signal must be obtained out on the plow wiring. **Two sets of 2-way sealed connectors** will be required as shown here. Extra mating halves can be used to fashion tethered caps. [Order GM service kit, 2 each M 2W 19119346 and 2 each F 2W 19119765 connectors]

