

# Multiplexing system installation

(the control module installed under power unit (pump cover))

## 53618-M

(it requires light kit 800084 or 800086)

Link to Install MPX controller harness (53625-MPX)

<https://www.youtube.com/watch?v=zphA600hF7g>

Link to install MPX light harness

<https://www.youtube.com/watch?v=VWAAZlv-WKA>

Link to install MPX lift frame harness (53627-MPX)

[https://www.youtube.com/watch?v=oT7hJj5h\\_q0](https://www.youtube.com/watch?v=oT7hJj5h_q0)

## Installation of Multiplexing System

### **Warning:**

- Top of battery needs to be protected. If positive side of battery is accidentally grounded person could be burnt or wiring system can be damaged, or battery gasses could explode causing injuries.
- Disconnect cable from negative battery terminal before starting installation.
- Always wear eye protection and protective clothing when working around hydraulic systems.
- Remove jewelry and objects that might conduct electricity while working on power units.
- Fluid under pressure can pierce the skin and enter the bloodstream causing death or serious injury.
- Hydraulic hoses and electrical cables (harnesses) must be tied and routed safely to avoid any damage and pinching (away from hot places, sharp objects etc.).
- When drilling mounting holes or using self-tapping screws in the engine compartment, be sure to check the mounting location for any wires, hoses other obstructions that could be damaged during installation.

### **Electrical installation of MPX system**

1. For Low Lift Frame M3493, first install plow antlers, braces and lights. For the curb side brace, insert the bottom ½" bolt from inside (only on the curb side) - see the pictures below.



2. Install the module (3) on the bracket (12) and attach the lift frame harness to the module. Install the pump plate on Hi Boy, with bolts inserted as show on the picture.

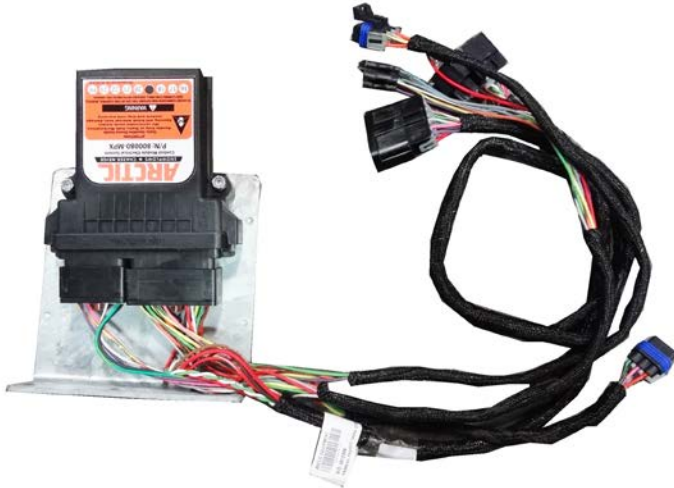

3. Install the module bracket inside of pump housing using 2 x 5/16" bolts(9), flat-washers (11) and nuts (10).



M3493 Low Mount Lift frame



Hi boy lift frame



4. Install lights. Using cable ties secure the light harness to the lift frame (2). Insert the light plugs into the pump cover housing.

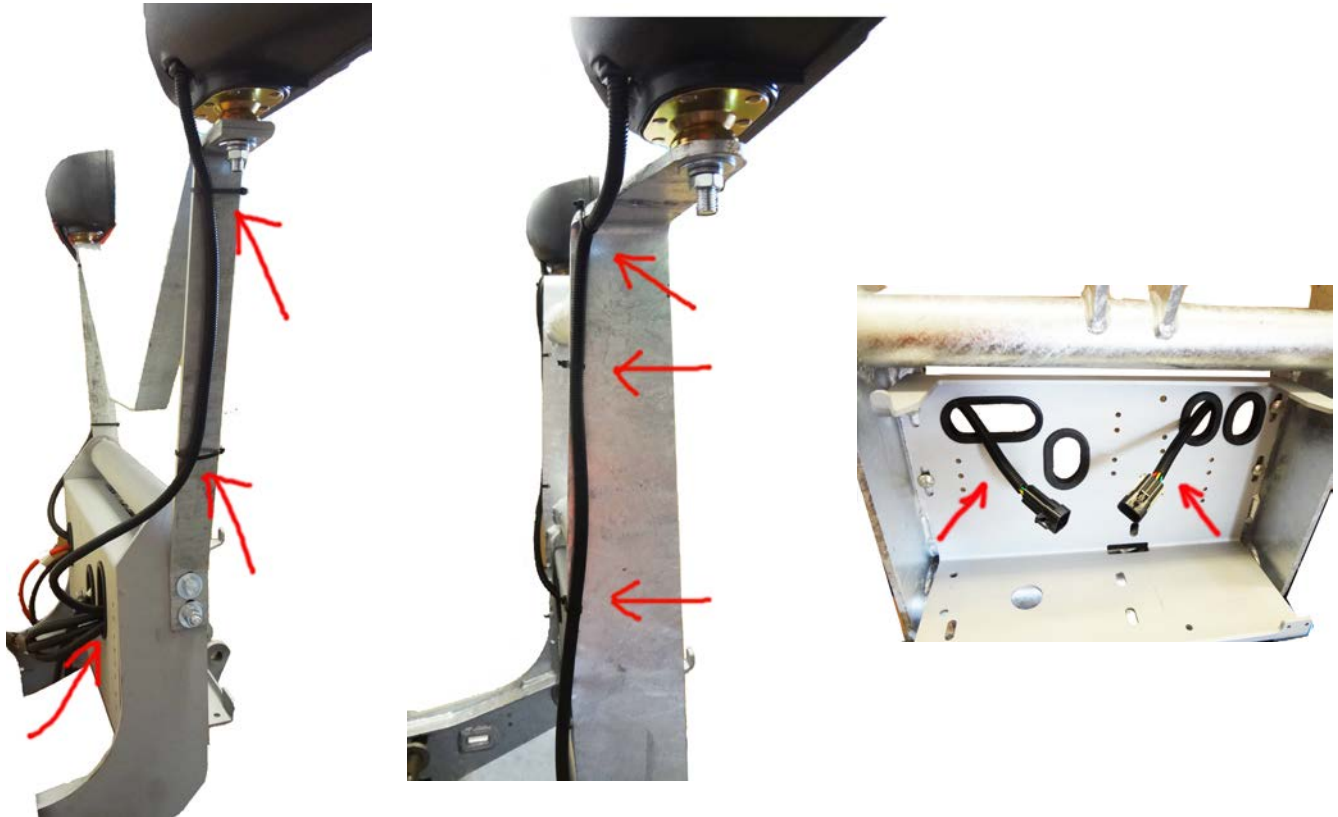

5. Install the power unit and secure it with 2 x 3/8" bolts and lock washers – using holes on the back side. (apply removable grade Loctite to 3/8" bolts to fasten power unit to the pump plate).

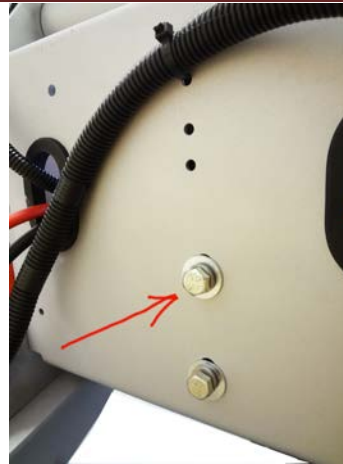

6. Install red terminal protector on cable and plug assembly (13). Attach red lead of the cable and plug assembly to positive motor stud and black lead to the pump base using 5/16" bolt.

Liberally coat connections with dielectric grease then slide cover over the eye on the end of the cable.



7. Secure the lift frame harness (2) and bring it toward the driver side.

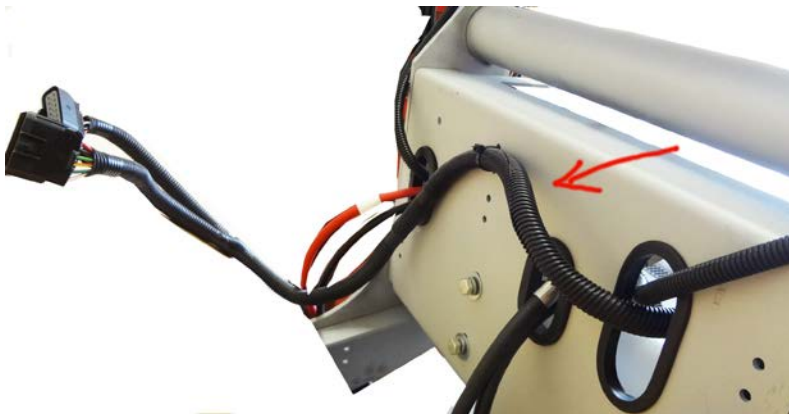

8. Plug the light connectors inside of the pump cover and secure them using zip ties. Connect the lift frame leads to the coils.

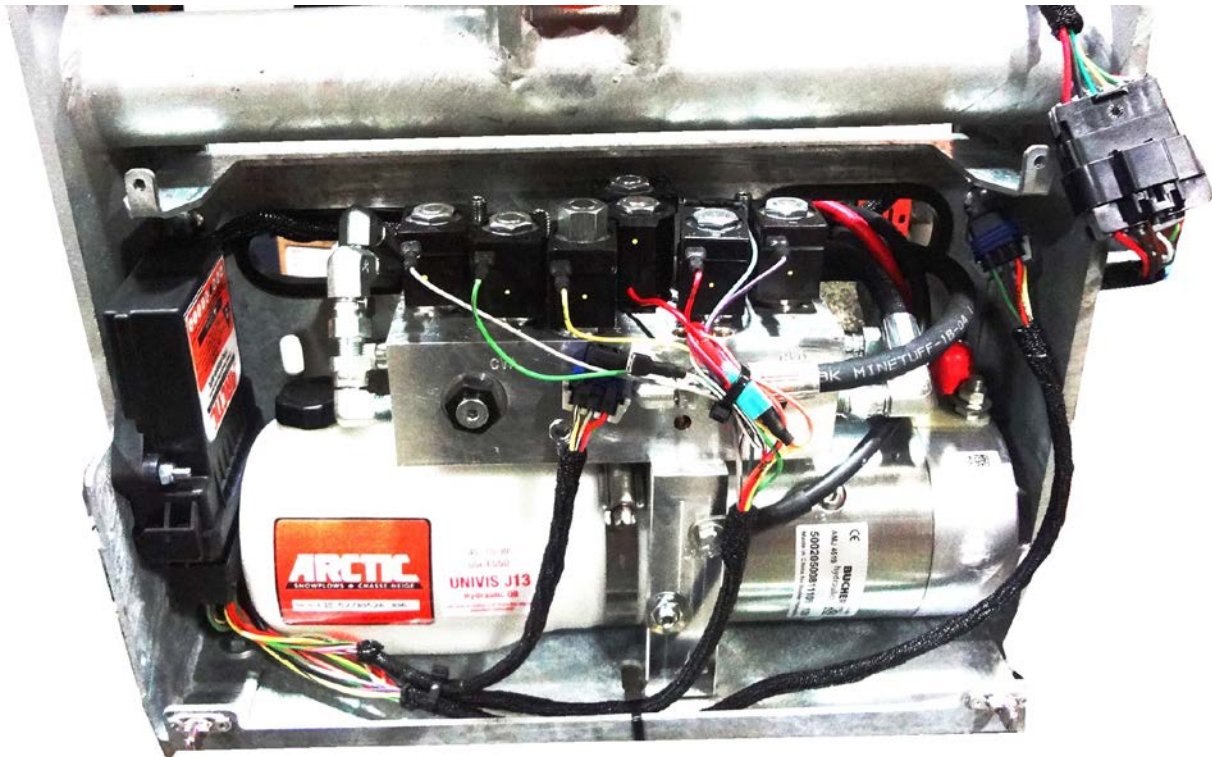

9. Mount the solenoid (16) to metal surface close to the driver (as show on the picture) bending bracket if necessary. NOTE: Solenoid must be well grounded in order to function properly.

10. Slide a dummy plug over power cable (15) and ground cable (14) and route through grille of truck leaving sufficient length to attach to the cable and plug assembly (13). Secure the red power cable (15) to the large terminal on the solenoid and the black ground cable (14) to the negative terminal on the battery.



11. Install power cable 22" (18) from the positive side of battery to one of the terminals of 135 AMP circuit breaker (19). Install 56" power cable (17) on the second terminal end on the circuit breaker terminal and to the large terminal on the solenoid (10). When installing the circuit breaker locate a flat surface suitable for mounting.

Choose surface that is clear of moving parts and extreme heat. The firewall or fender are possible mounting locations. Use ¼” bolts and locknuts. If an acceptable flat surface is not available, cable tie the circuit breaker securely to a harness or an existing bracket. Note: Make sure that chosen location is in a spot that will allow the power cables to reach their destination (see drawing).

12. For the underhood harness (1) locate a pass-through hole in the firewall near the driver’s side of the truck. Route the harness through the hole in firewall and attach to the controller. Install the light adapter harness (29).

See section below for Installation of Vehicle Harness RED/WHITE (ignition) wire.

### Installation of Vehicle Harness RED/WHITE (ignition) wire

Connect the RED/WHITE wire to a “keyed” 12V+ ignition source. Note: This 12V+ source should only be active when the key is in the ON position. Failure to wire to a “keyed” source can allow a condition to occur causing the battery to drain. This will also prevent operation of the plow without the vehicles key being on.

To find a “keyed” 12V+ ignition source, consult the fuse panel section of the vehicles owner’s manual. Look for a fuse labeled ACC/IGN or ACC (Accessory). Remove the fuse, apply the fuse tab as shown below and reinstall the fuse. The RED/WHITE ignition wire can now be plugged to the ¼” fast-on tab.

Note: Fuses and Fuse holders can also be found on the link below: (refer page 13)

[http://www.arcticsnowplows.com/sites/default/files/truck\\_side\\_repair\\_harness-website\\_7.pdf](http://www.arcticsnowplows.com/sites/default/files/truck_side_repair_harness-website_7.pdf)

Note: Check to make sure that the snowplow control ONLY has power when the vehicle ignition switch is ON.

If NO accessory fuse is available, a test light may have to be used to determine if power to a certain fuse (or any other power source) is “switched / keyed” or not.



Note: The RED/WHITE ignition wire is equipped with its own 10-amp fuse, so it can be tapped to any size fuse (10 or above). Do not use two taps on the same fuse.

13. Neatly secure all excess cables and wires using tie straps. Silicone hole in firewall.

Note: Be sure all cables are properly protected from any sharp edges or hot or moving parts!!

14. When the plow is not attached to the truck, plug the end connectors to each other to avoid the corrosion (on both sides, plow and truck side).



15. For hydraulic install refer to Hydraulic Installation section.

### Lighting System Procedure

**To avoid corrosion, extend the life of the control module & ensure proper plow functionality keep all connectors well-greased with dielectric grease.**

#### Basic Lighting Transfer Overview:

To transfer the lights from the vehicles headlights to the plow lights, the Control Module Electrical System installed on your vehicle must see or read four things.

- 1.) The vehicles ignition is turned ON.
- 2.) The vehicles headlight switch is turned ON.
- 3.) The plow is plugged in (by the vehicles grill).

Note: Keep in mind that turning the vehicles ignition OFF, acts as a RESET for the lighting system.

Below is a set of two conditions that may help to better explain the transfer of lights from vehicle to plow:

**\*\*When the vehicles ignition is turned OFF, the entire snowplow system is OFF. (Note: If this is not correct, see the plows installation instructions for proper plow installation).**

**Condition #1:** The vehicle's ignition is turned ON; the plow is NOT attached (and NOT plugged in) and the plow controller is OFF (or not plugged in). When turning ON the vehicle's headlight switch, the vehicles headlights will turn ON.

**Condition #2:** The vehicles ignition is turned ON; the plow is attached (and plugged in) and the plow controller is OFF (or not plugged in). When turning ON the vehicle's headlight switch, the plow headlights will turn ON.

MPX installation (parts can be found in kit part # 53618-M and pump kit)			
	Part#	Description	Quantity
1	53625-MPX	Under Hood MPX Harness	1
2	53627-MPX	MPX Lift Frame Harness	1
3	800080-MPX	MPX Control Module Box	1
4	53615-N	3/16" Mini Fuse Tap	1
5	HH-00360-098	#10-24 x 1.5 Pan Head Machine Screw	2
6	HH-00340-020	#10-24 Nylon Insert	2
7	53614-N	1/4" Fuse Tab	1
8	761354	1/4" Female Connector	1
9	HH-00293-028	5/16"-18 x1" HHCS	2
10	HH-00340-017	5/16"-18 Nut, Nylon Insert	2
11	HH-00341-003	5/16" Flat washer	2
12	53626-M	MPX Module Bracket	1
13	53476-B	18" Cable Plug Assembly	1
14	53477-B	90" Ground Cable (Black)	1
15	53478-B	90" Power Cable (Red)	1
16	FP17757	Solenoid	1
17	51335-56-M	Battery Cable, 56"	1
18	51335-22-M	Gauge Battery Cable, 22"	1
19	53608-N	Circuit Breaker	1
20	HH-00293-006	1/4"-20 x1" HHCS	1
21	HH-00294-001	1/4"-20 Hex Nut	1
22	HH-00457-006	1/4" Lock-washer	1
23	800084	Sealed Beam AXV Light Kit	1
24	800085	Single Bulb Head Light Kit	1
25	800086	Dual Bulb Head Light Kit	1
26	53282-MPX	Handheld Controller for Straight Blade	1
27	53495-MPX	Handheld Controller for Wing Blade	1
28	53326-MPX	Handheld Controller for V blade	1
29	---	MPX Light Adapter	1

Arctic Equipment Manufacturing Corporation reserves the right under its product improvement policy to change construction or design details and furnish equipment when so altered without reference to illustrations or specifications used.

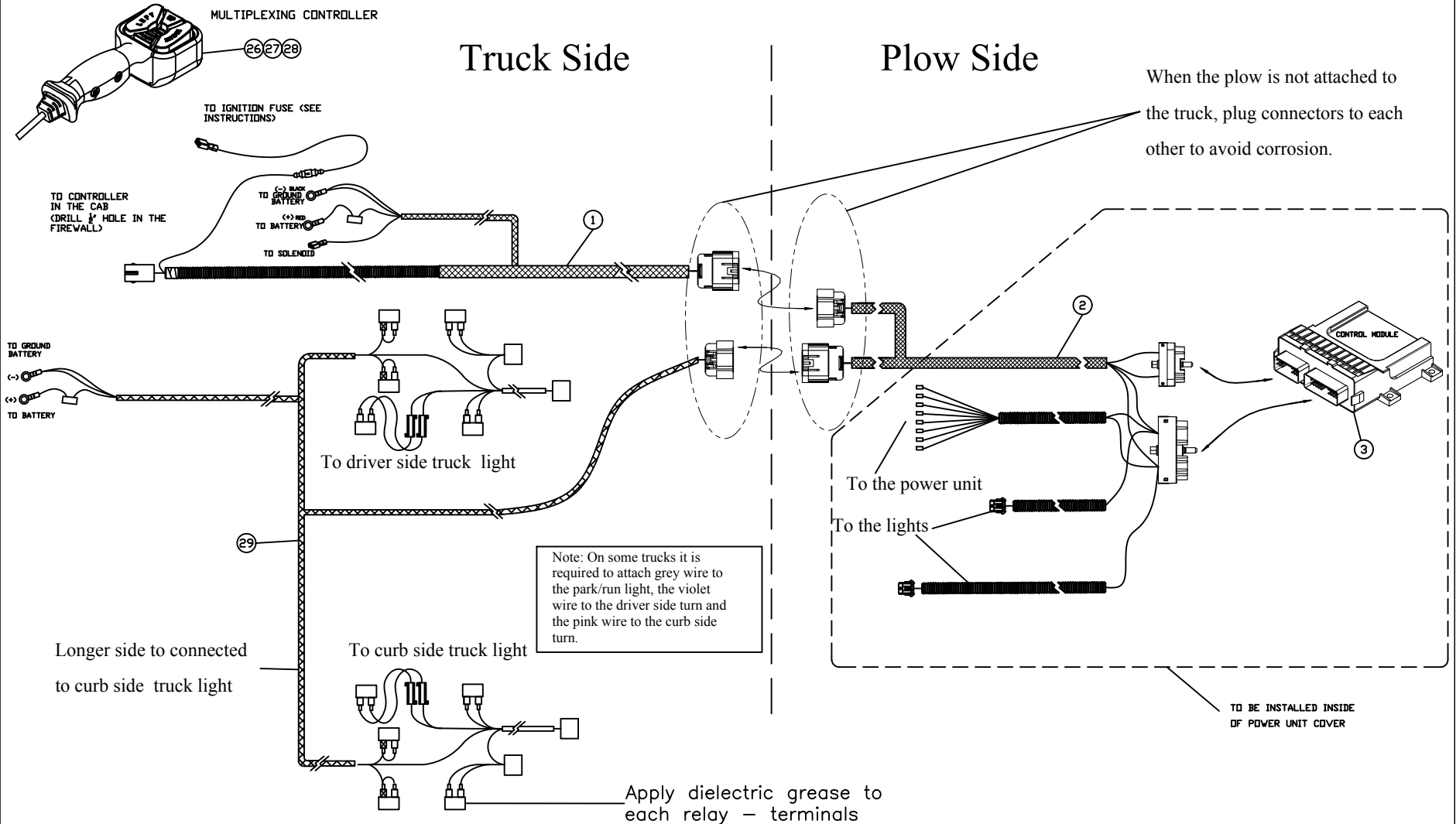

## CONTROL MODULE, MAIN HARNESS AND LIGHT ADAPTER – INSTALLATION

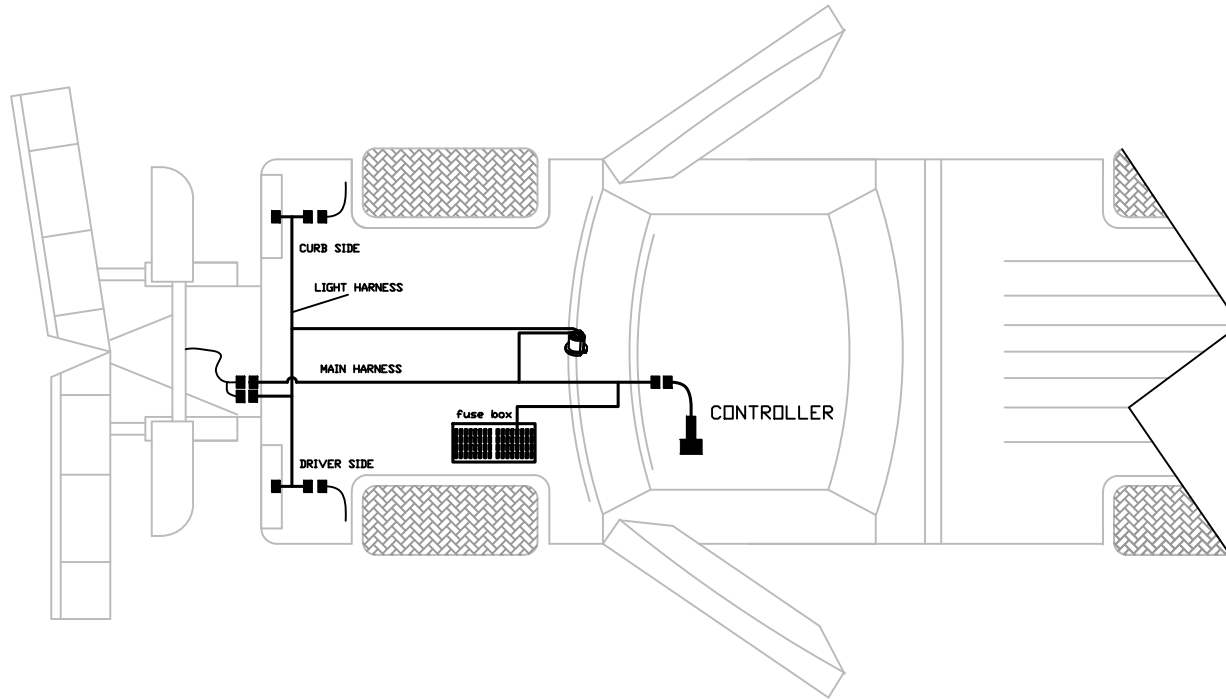

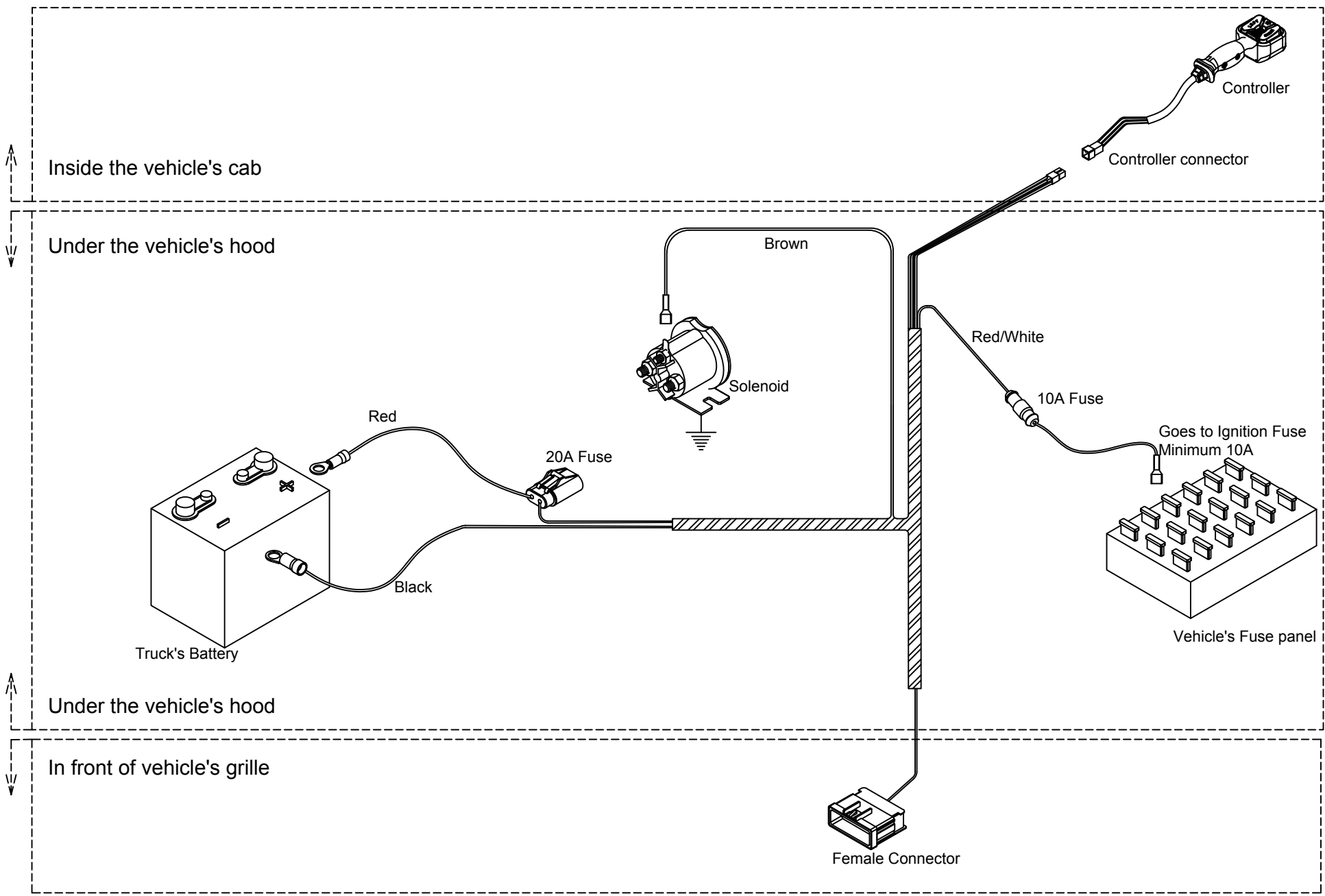

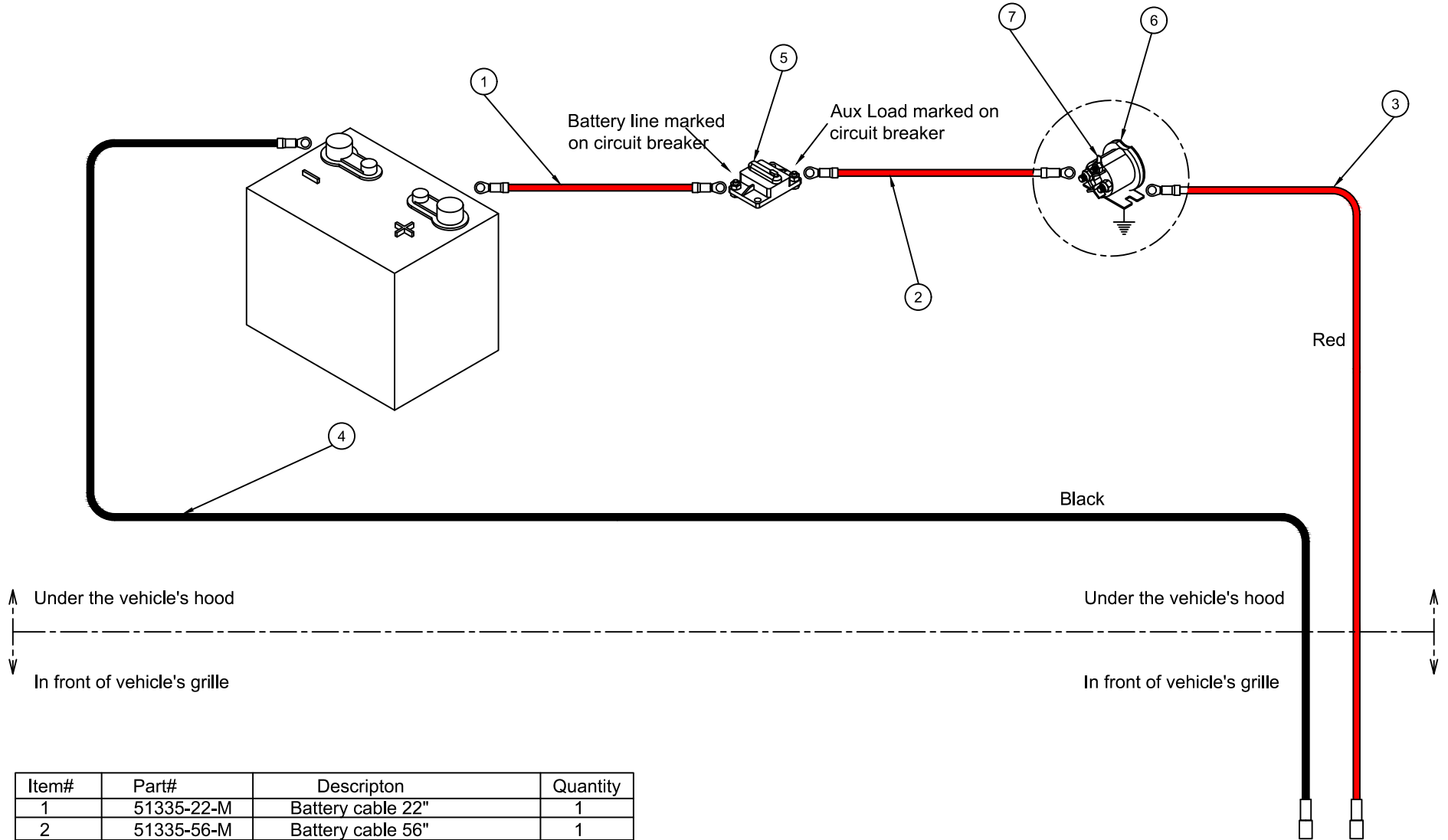

Item#	Part#	Description	Quantity
1	51335-22-M	Battery cable 22"	1
2	51335-56-M	Battery cable 56"	1
3	53478-B	90" Power cable	1
4	53477-B	90" Ground cable	1
5	53608-N	135 amps circuit breaker	1
6	FP17757	Solenoid	1
7	FP3414	#10 Blade terminal (Solenoid)	1

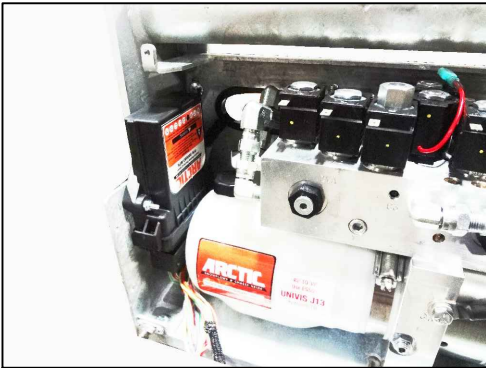

- Note:
- Use  $\frac{1}{4}$ " screw driver to tighten the plug into the box.
  - Apply torque of 15-20 IN LBS
  - Do not overtighten

Inside the power unit cover

In front of vehicle's grille

Installed on the lift frame

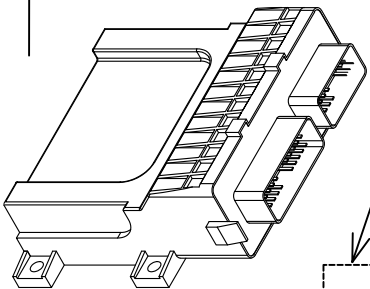

Installation to be done inside the power unit cover

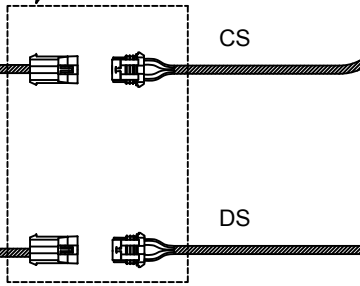

CS

DS

To power unit coils



Plugs together when not in use A  
(Apply grease)



CS Plow Headlight



DS Plow Headlight

Straight Blade		V Blade		Wing Blade	
Valve	Wire	Valve	Wire	Valve	Wire
A	Green	A1	Gray	A	White/Black
B	Yellow	A2	Green	B	Blue
C	Blue	B	Orange	C	Green
D	Red	C	Blue	D	Yellow
		D1	Purple	E	Red
		D2	Red	F	Orange
		E	Yellow	G	Gray
				H	Purple

Unused wires should be tied together

Inside the power unit cover

In front of vehicle's grille

LEGEND

DS - Driver Side  
CS - Curb Side

## Straight Blade

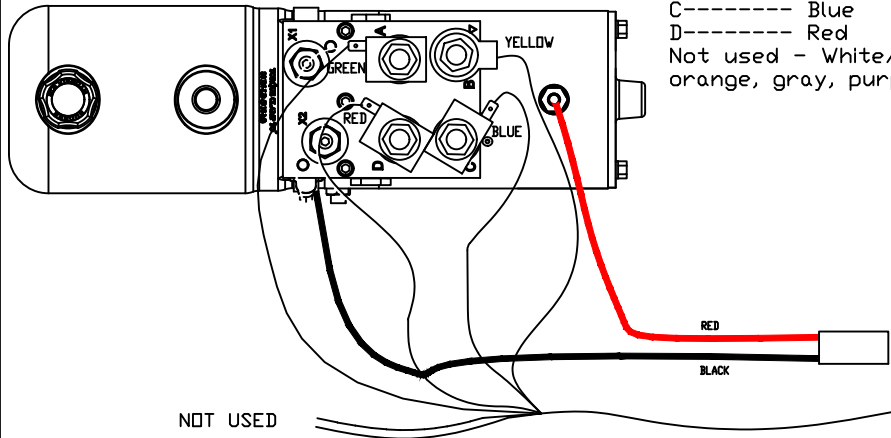

Lift frame harness

Valve	Wire
A-----	Green
B-----	Yellow
C-----	Blue
D-----	Red
Not used - White/black orange, gray, purple	

## Wing Blade

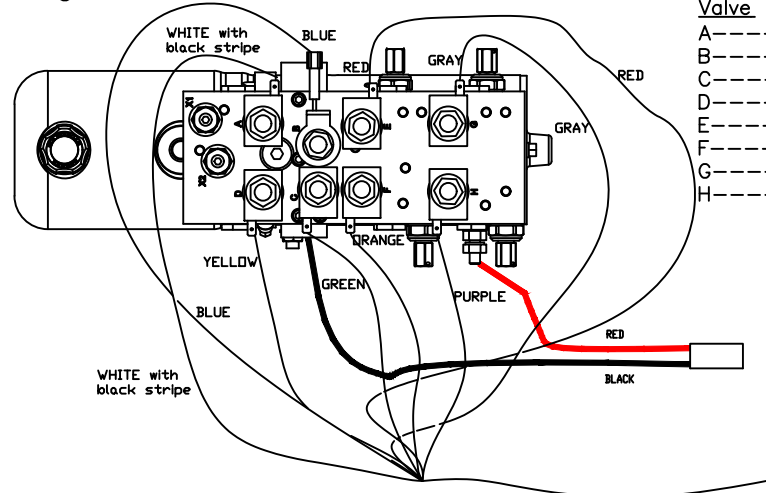

Lift frame harness

Valve	Wire
A-----	White/black
B-----	Blue
C-----	Green
D-----	Yellow
E-----	Red
F-----	Orange
G-----	Gray
H-----	Purple

## V Blade

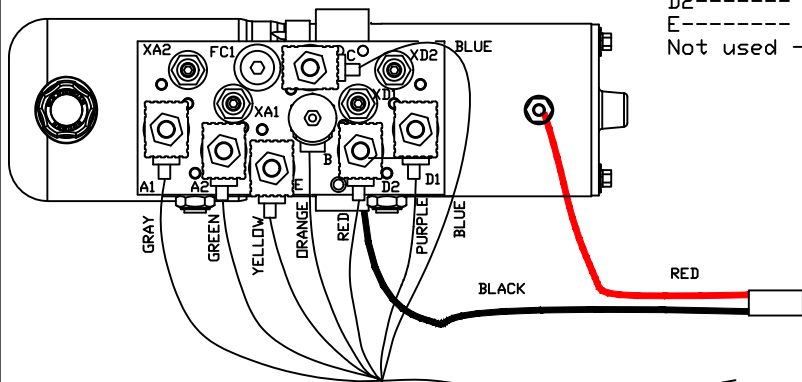

Lift frame harness

Valve	Wire
A1-----	Gray
A2-----	Green
B-----	Orange
C-----	Blue
D1-----	Purple
D2-----	Red
E-----	Yellow
Not used - White/black	

### Note:

- To avoid corrosion, keep connectors well greased with dielectric grease
- Apply grease on the coils and on the connectors that plugs into the coils

## Connectors alignment for the MPX system

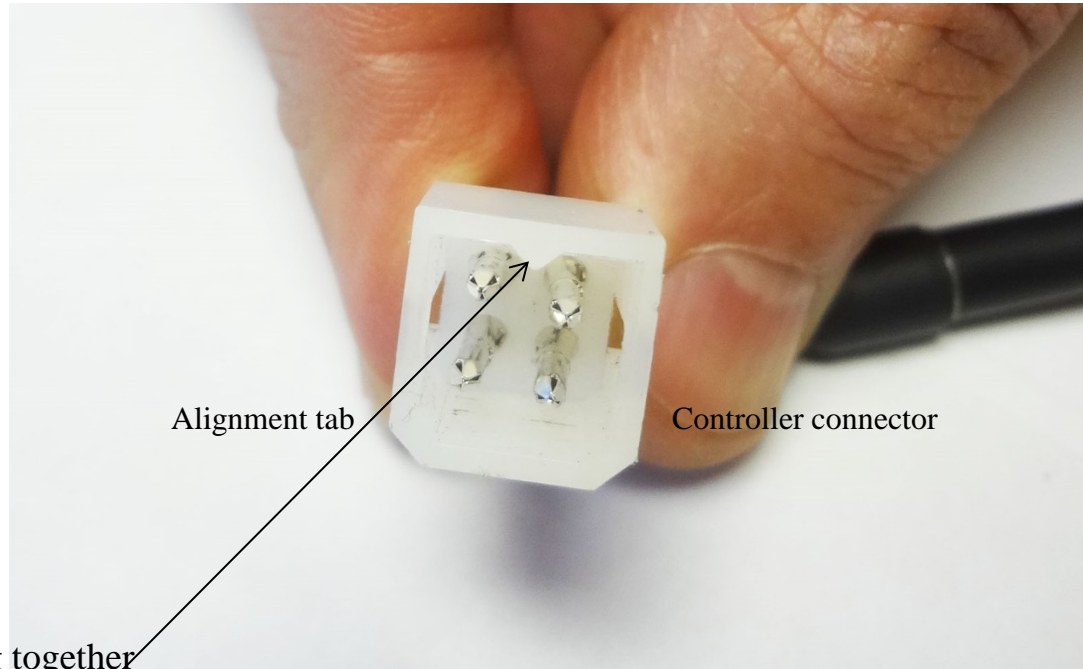

Must align before plugging together

